

**ELECTRO-OPTICS**

# ROMEO™

ROMEO3™ 1x25mm MINIATURE REFLEX SIGHT

**OWNERS MANUAL**

**SIG SAUER®**

## TABLE OF CONTENTS

Introduction . . . . .	3
Contents . . . . .	4
Key Features . . . . .	5
Product Identification . . . . .	6
Operation . . . . .	8
Mounting The Sight . . . . .	10
Sight Adjustments . . . . .	11
Maintenance . . . . .	13
Troubleshooting . . . . .	13
SIG SAUER® Electro-Optics Infinite Guarantee™ . . . . .	14
SIG SAUER Electronic Component Limited 5-Year Warranty . . . . .	15
Specifications . . . . .	16

This manual is available in the following languages: French, Spanish, German, Italian, Portuguese, Russian, Afrikaans, Swedish, and Norwegian. Please visit [sigoptics.com](http://sigoptics.com) for Owners Manual downloads.

## INTRODUCTION

The ROMEO3™ Reflex Sight is the ideal sighting solution for MSR/AR rifles, shotguns, carbines, sub-machine guns, or full size handguns. The ROMEO3 comes standard with a STANAG compliant M1913 Picatinny interface (some models include a QD 1.41" riser mount). The ROMEO3 Reflex Sight features a high transmittance red notch reflector for excellent brightness, light transmittance and zero distortion. A 3MOA Red Dot with multiple intensity settings ensures rapid target engagement under a full range of lighting conditions. Featuring MOTAC™ (Motion Activated Illumination System) that powers up when it senses motion and powers down when it does not providing optimum operational safety and enhanced battery life. The readily available CR2032 battery is side-loading, allowing for quick battery replacement without having to remove the sight from the firearm. The extremely strong and lightweight aircraft grade aluminum housing ensures a lifetime of reliable service.

The ROMEO3 Reflex Sight includes lens cover, adjustment tool, battery and operating instructions. The ROMEO3 is covered by SIG SAUER Electro-Optics Infinite Guarantee and SIG SAUER Electronic Component Limited 5-Year Warranty.

**CONTENTS:**

- ROMEO3™ 1x25mm Miniature Reflex Sight
- CR2032 Battery (1)
- Sight Cover
- Mount (some sights will ship with multiple mounts)
- Lens cloth
- Hex Keys

**KEY FEATURES:**

- High transmittance red notch reflector for excellent brightness, light transmittance, and zero distortion
- 3 MOA Dot with multiple intensity settings for rapid target engagement under a full range of lighting conditions
- MOTAC™ (Motion Activated Illumination System) powers up when it senses motion and powers down when it does not
- Aircraft grade CNC Aluminum housing ensures a lifetime of reliable service
- Dependable waterproof (IPX-7 rated for complete water immersion up to 1 meter) and fogproof performance
- SIG SAUER® Electro-Optics Infinite Guarantee™ and SIG SAUER Electronic Component Limited 5-Year Warranty.

## PRODUCT IDENTIFICATION:

- A- Reticle Intensity Increase Button
- B- Reticle Intensity Decrease Button
- C- Battery Tray
- D- Base Mount Screw
- E- Windage Adjustment
- F- Elevation Adjustment
- G- Windage and Elevation Adjustment Lock Screw
- H- Mount Screws

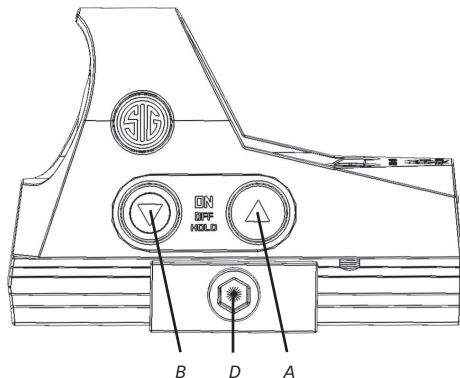

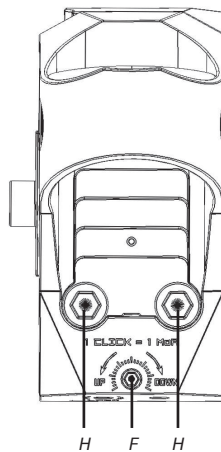
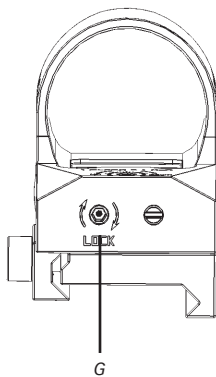
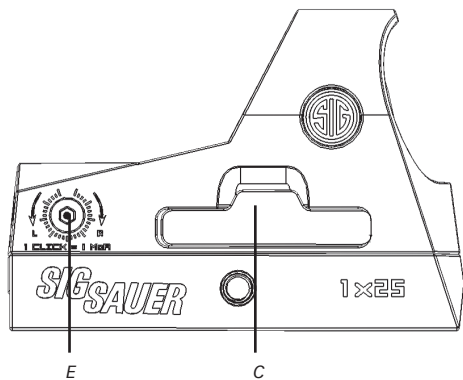

**⚠ WARNING**

Before working on your ROME03 sight always ensure that the firearm is unloaded with the safety on.

**OPERATION**

**Installing the battery**

The battery is located in a battery tray that can be accessed from the right side of the sight. Use a flat object to open the tray (To avoid damaging the anodized surface, use a plastic object or an object wrapped in electrical tape). Slide the tray out and replace the CR2032 battery positive side up. Slide the tray back into its original closed position.

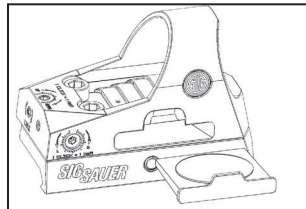
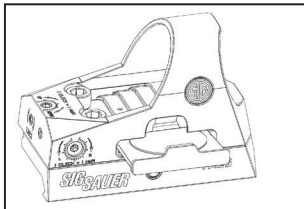
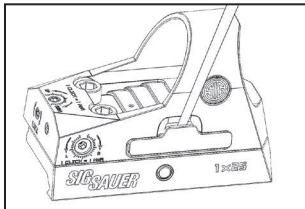



## Turning Sight On and Off

- Turn the sight on by pressing either the ▲ or ▼ power selector button.
- To turn the sight off, press and hold either the ▲ or ▼ power selector button for 3 seconds.
- The sight also features MOTAC™. Causing it to automatically turn off after 90 seconds if no motion is detected. As soon as the sight senses motion it will automatically power back on to the last setting.
- The ROMEO3 has 11 illumination settings, 9 daytime and 2 NV. To increase the intensity of your 3 MOA dot press the ▲ button on the left side of the sight. To decrease the intensity press the ▼ button.

## MOUNTING THE SIGHT

- Selecting your mount- Some models of ROMEO3 sights come with two mounts, a low-rise mount or a QD 1.41" co-witness mount. In order for the ROMEO3 to co-witness with your standard AR platform iron sights you will need to use the QD 1.41" co-witness riser. Most other applications will require the low-rise mount.
- Once you have selected the correct base for your sight you will need to secure the sight to the base. This is done with two mounting screws at the top of the sight. Align the sight on the base and tighten these two screws to 1.5 Nm (15 in-lbs).
- The ROMEO3 was designed for use on most types of firearms that utilize the MIL-STD 1913 Picatinny Rail. Because the ROMEO3 has infinite eye relief, the sight can be mounted anywhere on the firearms rail system forward or back. Make sure that there is access to the sight's lock screw at the rear of your sight. If using the low profile base tighten down the ROMEO3 base to the MIL-STD 1913 rail 2 Nm (18 in-lbs).
- If using the QD 1.41" co-witness riser, tighten the mount by closing the quick release lever and tightening the torx screw on the opposite side to 2 Nm (18 in-lbs).

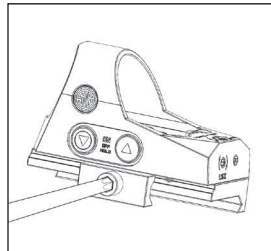
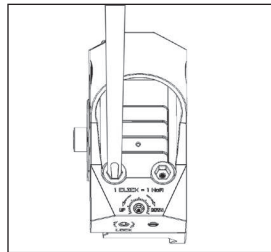

## SIGHT ADJUSTMENTS

- You must always loosen the lock screw at the rear of your sight before making windage or elevation adjustments. Loosen the lock screw by turning it counter-clockwise

**⚠ CAUTION** – Failure to loosen the lock screw before making changes to your windage and elevation adjustments will damage the sight.

- Elevation adjustments – the elevation adjustments are on the top of your sight. To raise your point of impact, with the provided Allen key, turn the adjustment counter-clockwise. Each click is equal to 1 MOA. To lower the point of impact turn the adjustment clockwise.
- Windage adjustments – the windage adjustments are on the right

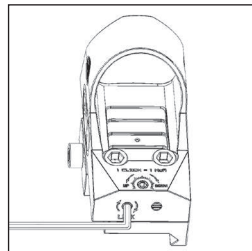
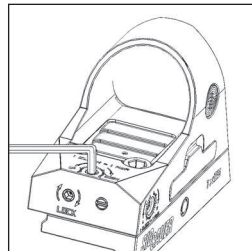

side of your sight. To move your point of impact to the left, with the provided hex key, turn the adjustment counter-clockwise. Each click is equal to 1 MOA. To move the point of impact to the right turn the adjustment clockwise.

- Locking your point of impact adjustments – make sure that you always lock your windage and elevation adjustments. The lock screw is located at the rear of the sight. Turn the lock screw clockwise until it reaches 1 Nm (9 in-lbs)

**⚠ CAUTION** – Failure to lock the windage and elevation adjustments will result in point of impact drift.

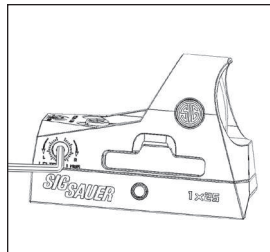

## MAINTENANCE

- Cleaning – Keep your lenses clear by using a soft cloth or lens pen. The best way to maintain image quality is by keeping your lenses clear of dirt and dust that cause scratches.
- Always use your sight cover to ensure that the sight optics remain scratch free.
- Replacing the battery- The battery is located in a battery tray that can be accessed from the right side of the sight. Use a flat object to open the tray. Slide the tray out and replace the CR2032 battery positive side up. Slide the tray back into its original closed position.

\*Do not remove protective rubber material in upper right corner on the rear-facing surface of the sight. This material is integral for waterproofing

## TROUBLESHOOTING

POI changes between groups

- Check that all of your mounts are tightened to the correct torque spec
- Check that the windage and elevation adjustments are locked
- Check/Clean your firearm
- Check for variations in ammunition



### **SIG SAUER Electro-Optics Infinite Guarantee™**

SIG SAUER has manufactured the most rugged, dependable high-performance firearms for over two centuries. Our heritage of design, engineering and precision-manufactured quality predates the existence of any other optics company worldwide. We understand the importance of quality in the line of fire, at the shooting range or on your next hunt. SIG SAUER Electro-Optics had to earn the right to wear that badge and the Infinite Guarantee has your back, forever. Period.

We will repair or replace your SIG SAUER product in the event it becomes damaged or defective, at no charge to you. If we cannot repair your product, we will replace it with a product in perfect working order of equal or better physical condition. It doesn't matter how it happened, whose fault it was, or where you purchased it.

### **SIG SAUER Infinite Guarantee™**

- Unlimited Lifetime Guarantee
- Fully Transferable
- No Warranty Card Required
- No Receipt Required
- No Time Limit Applies
- No Charge

If you ever have a problem, no matter the cause, we promise to take care of you when it counts. Please note that our Infinite Guarantee does not provide coverage for intentional damage, misuse, cosmetic damage that does not affect the performance of the optic, loss, theft or unauthorized repair or modification. Excludes electronic components.



### **SIG SAUER Electronic Component Limited 5-Year Warranty**

For components not included under the SIG SAUER Infinite Guarantee, this warranty covers any defects in materials and workmanship in the electronic components of illuminated riflescopes/sights, electronic sights, flashlights, lasers, binoculars, spotting scopes and rangefinders. This warranty lasts for five years from the date of manufacture. If, during that five-year period, these products are found to have electronic component defects in materials or workmanship, SIG SAUER will repair your product, at no charge to you. If we cannot repair your product, we will replace it with a product in perfect working order of equal or better physical condition. This warranty gives you specific legal rights, and you may also have other rights which vary from state to state.



**ROME03 SPECIFICATIONS**

<b>Magnification</b>	1x25mm
<b>Illumination Settings</b>	9 Daytime / 2 NV
<b>Window Height</b>	.8 in / 21mm
<b>Window Width</b>	1.01 in / 25mm
<b>Elevation Adjustment Range</b>	40 MOA
<b>Windage Adjustment Range</b>	40 MOA
<b>Weight</b>	1.4 oz / 40 g
<b>Battery</b>	CR2032
<b>Waterproofing</b>	IPX7



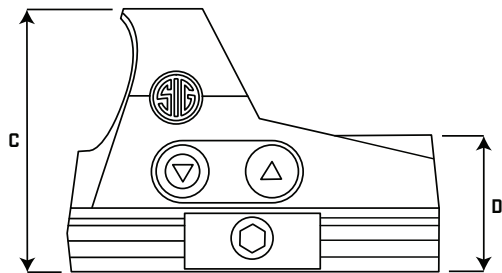
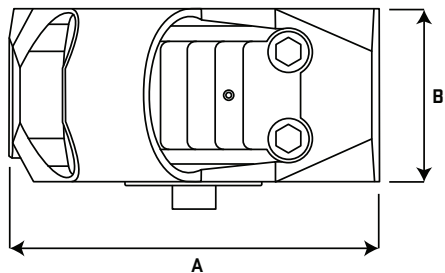

- A – 2.3 in / 58mm
- B – 1.2 in / 30mm
- C – 1.7 in / 42mm
- D – 1.3 in / 33mm

**NOTES:**





**FOR PRODUCT SERVICE ON THIS MODEL, PLEASE CALL 603-610-3000**

19861 SW 95th Avenue, Portland, OR 97062 USA